



WI400: the first PHP “*i-Framework*”

WI400 Team

info@siri-informatica.it



Agenda

- ▶ **Modernizzare e IBMi**
- ▶ **I Principi delle interfacce**
- ▶ **L'evoluzione dei modelli culturali**

IBMi e “modernize”

Il sistema IBMi

- ▶ solidità
- ▶ affidabilità
- ▶ protezione degli investimenti
- ▶ larghissima diffusione di applicazioni.....



Perchè allora quando si parla di IBMi si parla anche sempre di “modernizzare ?”

- ▶l'interfaccia...

```
sales system - Model W32 TN5250
File Edit View Settings Help
Open Close Copy Paste Print About Quit Clear Run Sysreq Help Hex
Programmer Menu
System: V400x

Select one of the following:
1. Start AS/400 Data File Utility
2. Work with AS/400 Query
3. Create an object from a source file  object name, type, pgm for CMD
4. Call a program                      program name
5. Run a command                       command
6. Submit a job                        (job name) , , (command)
7. Go to a menu                        menu name
8. Edit a source file member           (srcmbx) , (type)
9. Design display format using SDA     (srcmbx) , (mode)
10. Sign off                           (*nolist, *list)

Selection . . . . . Parm . . . . .
Type . . . . . Parm 2 . . . . .
Command . . . . .

Source file . . . . . Source library . . . . . *LIBR
Object library . . . . . Job description . . . . . *MSRPF

PC-Exit          PC-Prompt          PC-Display messages  PC-Command entry
PL-Cancel        PL-Work with submitted jobs  PL-Work with output
Print operation complete to the default printer device file.

ONLINE X-HLP 15,24
```



Principi delle interfacce

“La caffettiera del masochista”
di Donald A. Norman - Giunti Editore 1997

La psicopatologia degli “oggetti quotidiani”

- ▶ professore emerito presso il celeberrimo MIT (Massachusetts Institute of Technology)
- ▶ vicepresidente del gruppo ricerca sulle tecnologie avanzate per Apple
- ▶ ha scritto una tagliente critica sulla scarsa ergonomia delle interfacce



..se hai problemi a capire quando spingere o tirare
una porta..non è colpa tua...

Principi delle interfacce - cattivi esempi

Il design dei Fornelli

- ▶ la relazione tra manopole e fornelli è in buona parte arbitraria

- ▶ I fornelli

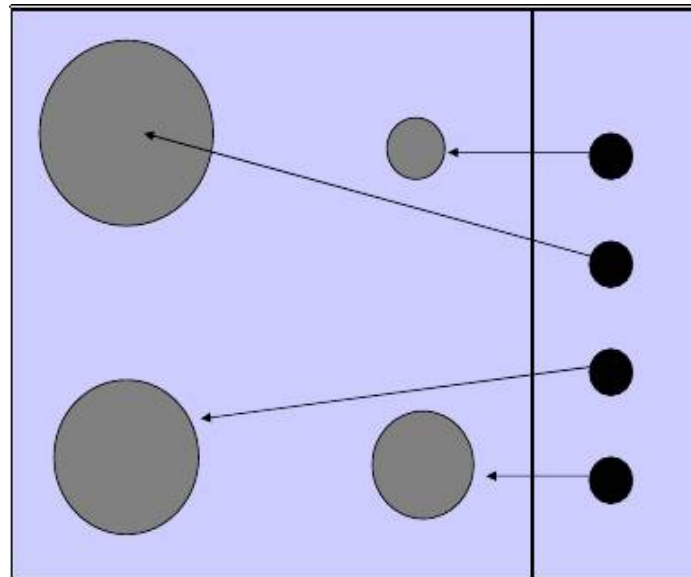

Principi delle interfacce - cattivi esempi

Il volume della sveglia

- ▶ la violazione di un modello culturale consolidato
- ▶ Perché il volume si alza “*abbassando*” ?



IBMi e la “gui”

Le evoluzioni della “Graphical User Interface”

- ▶ lo screen scraping
- ▶ il refacing
- ▶ il capture “data streaming”
- ▶ data xml flow transfer



Risultato finale....

- ▶ il 5250 su un nuovo dispositivo..

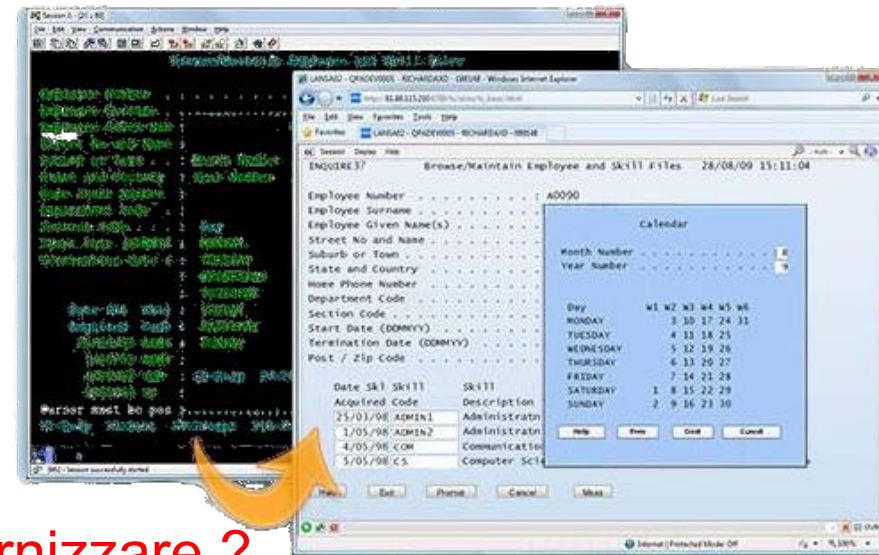

Questo è modernizzare ?

L'evoluzione dei modelli culturali

rss – feed – news - wsd



Chioschi – TouchScreen

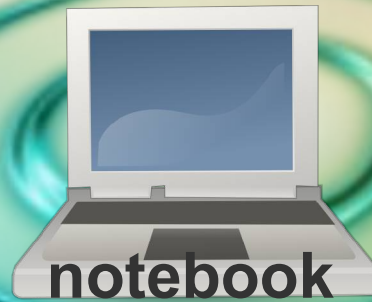

smartphone



biglietterie



Sono richieste nuove esigenze all'IT

- Implementare I servizi



- Connettere il DB2 ad altri DB



- Integrazione con altre Piattaforme



- Proteggere gli investimenti



- Ottenere benefici da applicazioni FOSS





Lo strumento giusto

- la storia php

Un Pò di Storia

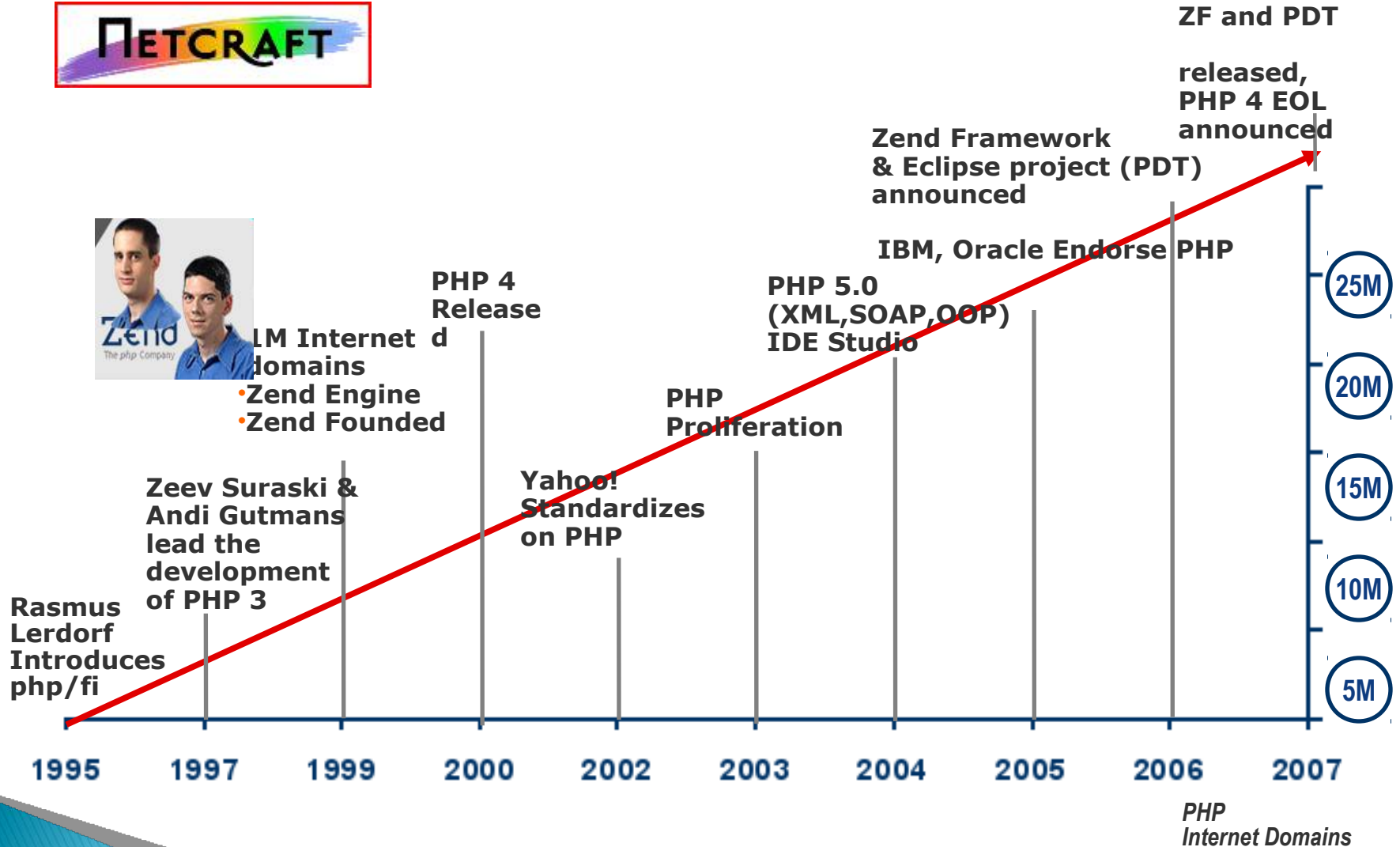

PHP
Internet Domains

PHP - stato dell'arte

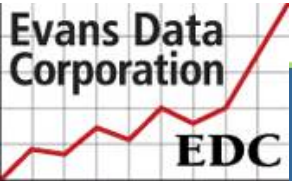

Worldwide Developers	2006	%	2007	%	Growth%
Java	5,863	44%	6,806	47%	+16%
.Net	6,420	48%	8,176	57%	+27%
PHP	4,634	35%	6,426	44%	+37%
Total	13,315		14,461		

Cos'è il PHP - dettaglio: vantaggi



Bassa curva di apprendimento

Apprendimento rapido



Robusto, Multi-Piattaforma, Alte-Performance, Sicurezza

Affidabile



Folta Community

Larga diffusione



PHP in IBMi

| - quali sono le novità ?

April 3 2006: IBM annuncia un accordo per più anni con Zend technologies per avere il PHP nativo sul sistema

ZendCore/ZendServer for I5/OS

- ▶ PHP nativo
- ▶ Disponibile da V5R3, V5R4 and V6R1
- ▶ Free of charge



ZendStudio for Eclipse i5 Edition

- ▶ Sistema di sviluppo client basato su Eclipse
- ▶ Disponibile su Windows, Linux, mac OS x
- ▶ Free of charge



ZendCore e ZendStudio for I5/OS sono inclusi nei nuovi IBMi

- ▶ Nella nuove macchine V5R4 and V6R1
- ▶ 1 anno di silver support
- ▶ Disponibile da February 6, 2009

new !



ZendServer for I5/OS: evoluzione dello ZendCore

- ▶ Nuova versione del PHP 5.3
- ▶ 1 anno di silver support
- ▶ Disponibile in GA da Aprile, 2010



PHP & IBMi: prerequisites

- **release V5R3/V5R4/V6R1**
- **5722SS1 - opt 33** Portable app. solutions Environ.
- **5722SS1 - opt 30** Qshell
- **5722SS1 - opt 13** System Opennes Includes
- **5722SS1 - opt 34** Digital Certificate Manager
- **5722AC3 - opt *BASE** Crypt access provider (**V5R3**)
- **5733SC1 - opt *BASE** Portable Utilities (**eng only**)
- **5733SC1 - opt 1** OpenSSH,Open SSL,Zlib (**eng only**)

PHP & IBMi: installation

- RSTLICPGM LICPGM(1ZCORE5) - per lo ZendCore
- RSTLICPGM LICPGM(2ZSVRPI)- per lo ZendServer

Visualizzazione programmi su licenza installati

Sistema

Program. su lic.	Release installato	Descrizione
1ZCORE5	V5R3M0	Zend Core for IBM i5/OS (2.6.1)
2ZSVRPI	V5R4M0	Zend Server for IBM i 5.0.1 (PHP 5.3)

PHP & IBMi: configurazione ZendCore

Power Systems

Access from Internet

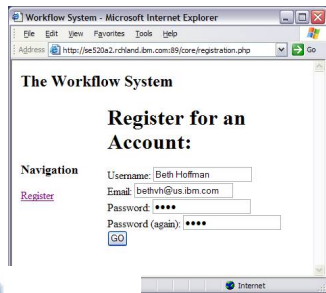

Different system
Linux/Windows

Request
Response

Apache
HTTP Server
:porta 89

Reverse Proxy

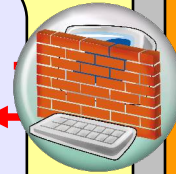

i5/OS
PASE
5722SS1 Opz.33

<?php
.....
HTTP Server
localhost:8000



PHP & IBMi: configurazione ZendServer

Power Systems

Access from Internet

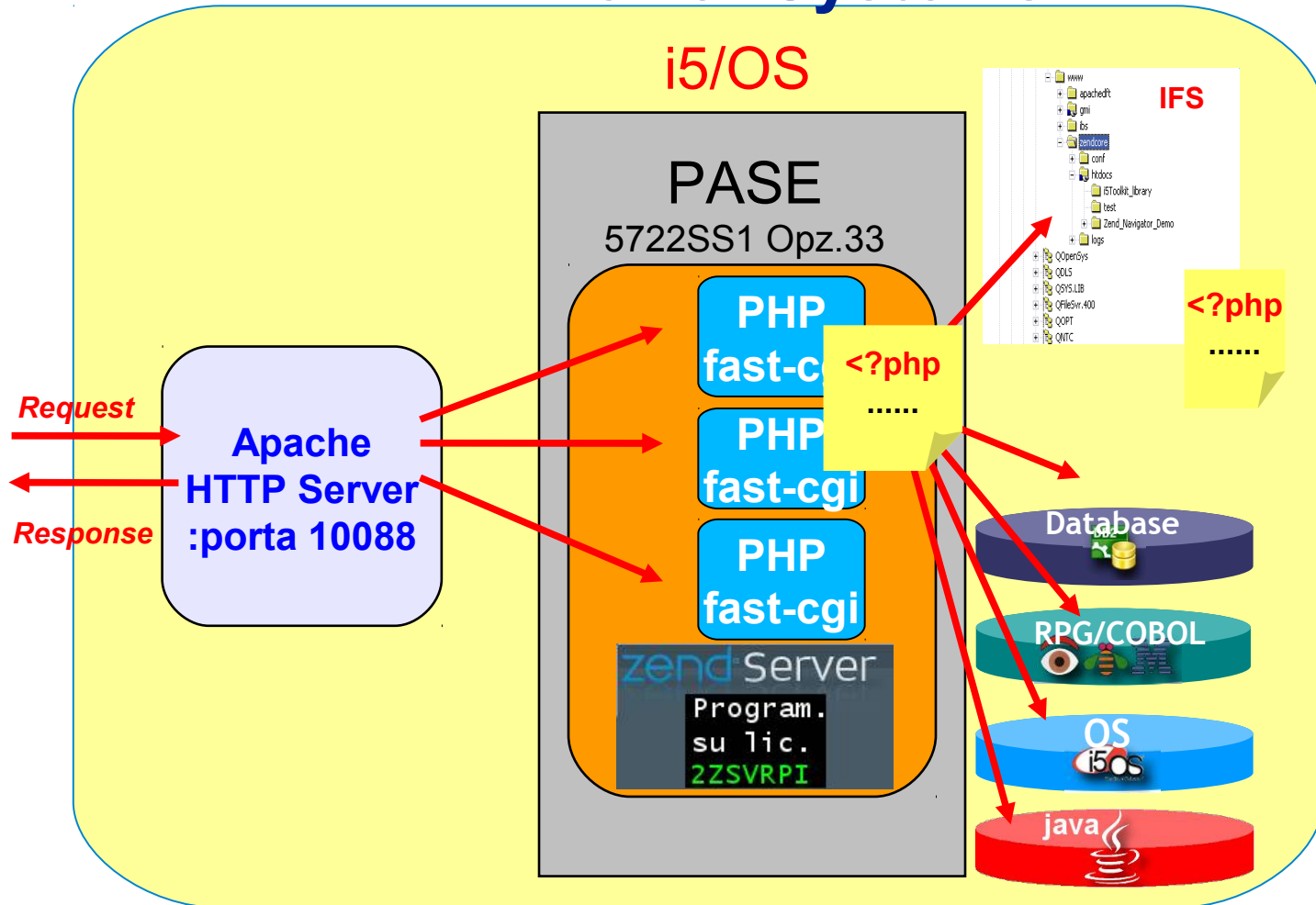

PHP & IBMi: configurazioni alternative

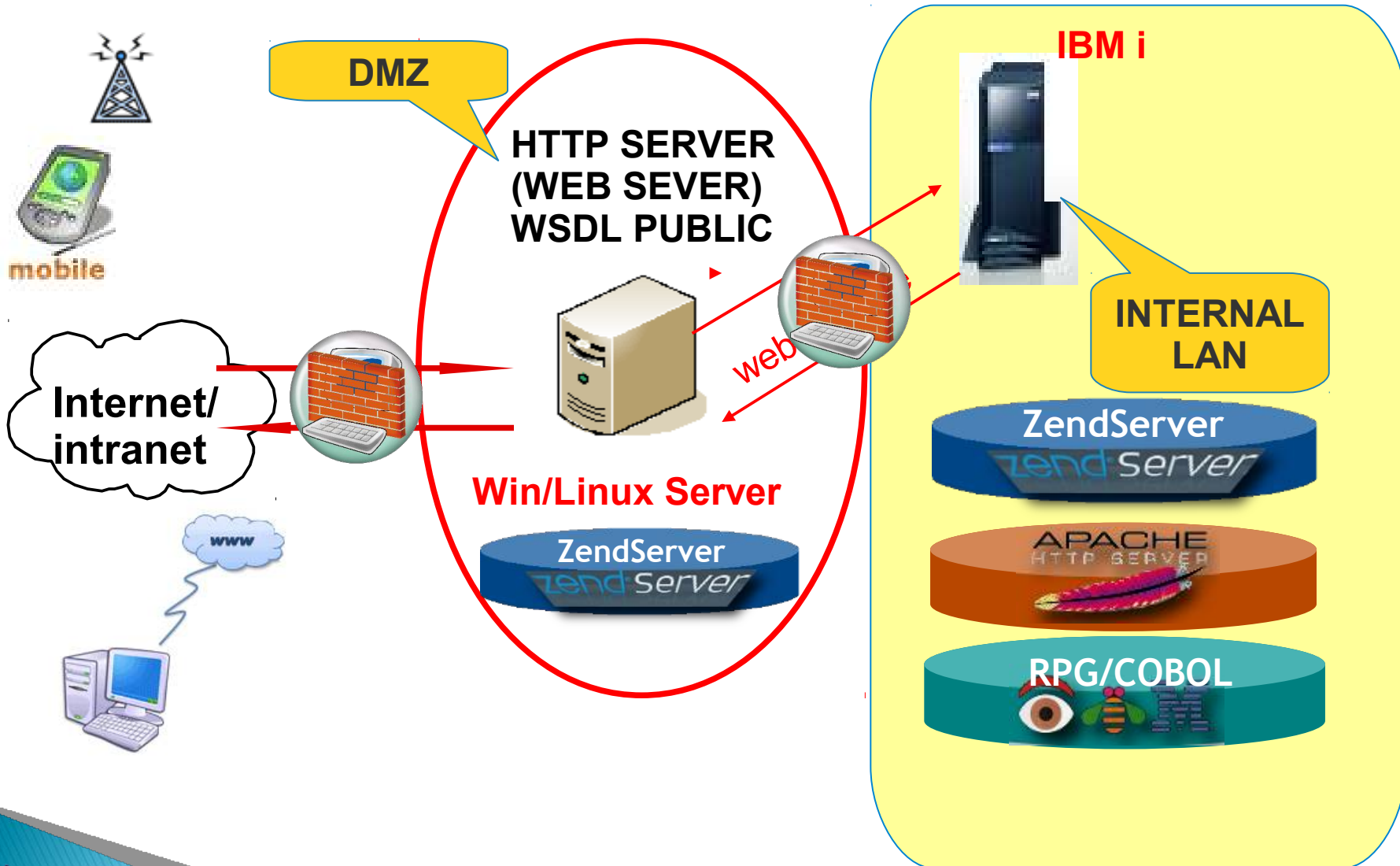

PHP & IBMi: estensioni

zend Server

Monitor | Rule Management | Server Setup | Administration

Components | Extensions | Directives | Debugger | Monitor | Job Queue | 5250 Bridge

| Status | Extension Name | Current State | Action | Link |
|--------|----------------|---------------|--------------------------|----------------------------|
| ON | tokenizer | Built-in | | Directives |
| ON | ftp | | Turn off | |
| ON | gd | | Turn off | Directives |
| ON | gettext | | Turn off | |
| OFF | gmp | | Turn on | |
| ON | hash | Built-in | | |
| ON | ibm_db2 | | Turn off | Directives |
| ON | iconv | | Turn on | Directives |
| ON | imagick | | Turn off | Directives |
| ON | imap | | Turn off | |
| ON | intl | | Turn off | Directives |
| ON | json | | Turn off | |
| ON | ldap | | Turn off | Directives |
| ON | libxml | Built-in | | |
| ON | mbstring | | Turn off | Directives |
| ON | mcrypt | | Turn off | Directives |
| OFF | memcache | | Turn on | Directives |
| ON | mssql | | Turn off | Directives |
| ON | mysql | | Turn off | Directives |
| ON | mysqli | | Turn off | Directives |
| ON | openssl | Built-in | | |

PHP & IBMi: l'IDE per IBMi

File manager

- file system
- project

Design

- table
- button
- field

Editor

- Syntax highlighting
- syntax cheking
- code completion

Palette Toolbox

- table
- Html
- Form
- Link
-

Inspector

- File
- Project
- PHP
- Css

Debug messages

- Error
- Warning

```
<?php
require_once ("login.php");

global $stmt, $result;
$value="";
$value=@$_REQUEST['valore'];
// tabella
$table='anc1200f';
// lista di campi
```

PHP & IBMi: l'IDE per IBMi

The screenshot shows the 'Database Development - Zend Studio for Eclipse' interface. On the left, the 'Data Source Explorer' shows a tree structure of SQL Databases, including 'mammoth (DB2 UDB for AS/400 v. 5.2.0)' and its catalogs and schemas. A yellow callout bubble labeled 'DataBase Navigator' points to this tree, containing the text '• pf' and '• lf'. In the center, the 'Sql Browser' displays a table with columns for 'Operation', 'Date', and 'Result1'. The table contains 10 rows of data. A yellow callout bubble labeled 'Sql Browser' points to this table. At the bottom, a terminal window shows a 'Visualizzazione membro file fisico' command with output details. A large white callout bubble with the text 'More "user friendly" than 5250....' is overlaid on the terminal window.

DataBase Navigator

- pf
- lf

| Operation | Date | Result1 |
|-----------|----------|---|
| 1 | 07/02/0: | ATA02 NRA02 DAA02 CODAG DSCAG PROAG LQPAG |
| 2 | 07/03/0: | 30834 21668 20070... 001 ANDRE... 7.00 F |
| 3 | | 21668 20060... 002 ANDRE... 4.00 P |
| 4 | | 21668 20060... 003 AGENT... 7.00 F |
| 5 | | 21668 20060... 004 AGENT... 4.00 F |
| 6 | | 21668 20060... 005 AGENT... 2.00 F |
| 7 | | 21668 20060... 007 ANDRE... 2.00 F |
| 8 | | 30834 20070... 008 M.F. ... 7.00 F |
| 9 | | 30834 20070... 009 M.F. ... 4.00 F |
| 10 | | 30834 20070... 010 M.F. ... 2.00 F |

Sql Browser

```
Visualizzazione membro file fisico
File . . . . . : ANCL200F      Libreria . . . . . : DAT_CAYVE
Membro . . . . . : ANCL200F      Record . . . . . : 1
Controllo . . . . . :          Colonna . . . . . : 1
Ricerca . . . . . :
*...+...1...+...2...+...3...+...4...+...5...+...6...+...7...+...8...
AI ?000001CAVALLARO PINO & C. S.N.C.
o ±0000022 ERRE COPY S.N.C.DI RUSSO M.& C.
E re j 0000032 ZETA DI ZAMARDO R.
E re j 000005A G... ROVIGO
E re j 000006A.C.A.I. ASS.CRISTIANA ARTIGIANI
ek j 000007AUTOMOBILE CLUB ROVIGO      SEDE PROVINCIALE DELL'A.C.I.
```

More "user friendly" than 5250....



Integrazione in IBMi

| - in che modo ?

Integrazione: toolkit

Toolkit permette di interagire nativamente con gli oggetti di i5/OS

- ▶ DB2 for IBM i
- ▶ Programs
- ▶ Data areas
- ▶ Data queues
- ▶ Message queues
- ▶ System values
- ▶ commands
- ▶ Spool files
- ▶ joblog
- ▶ Run sql statements

Tutte le API's vengono identificate da **i5_**

Integrazione: toolkit

```
1 <?php
2 header("Content-Type: text/html;charset=UTF-8");
3 require_once('i5_connect.php');
4
5 // lancio comando in shell
6 $cmd=i5_command("wrkactjob output(*print)" array(),array(),$conn);
7 if(!$cmd) {
8     die("errore lancio comando: " . i5_errormsg($conn));
9 }
```

da uno script PHP
è possibile eseguire
un i5/OS command

Integrazione: toolkit

risultato di un
i5/OS command

```
WRKACTJOB from PHP - Mozilla Firefox
http://i5demo.zend.com/wrkactjob.php
Pusher Demo translate i5 Forum sugar45db2-demo i5 Articles it Maps support webmail Welcome to Zend Cor... IBM IBM SugarCRM-Zend i5 D...

WRKACTJOB from PHP
5722SS1 V5R4M0 O60210 Work with Active Jobs 07/05/08 13:01:32 Page 1
Reset . . . . . : *NO
Subsystems . . . . . : *ALL
CPU Percent Limit . . . . . : *NONE
Response Time Limit . . . . . : *NONE
Sequence . . . . . : *SBS
Job name . . . . . : *ALL
CPU % . . . . . : .0 Elapsed time . . . . . : 00:00:00 Active jobs . . . . . : 303

Current -----Elapsed-----
Subsystem/Job User Number User Type Pool Pty CPU Int Rsp AuxIO CPU% Function Status Threads
QBASE QSYS 711718 QSYS SBS 2 0 .6 0 0 0 .0 DEQW 2
QACSOTP QUSER 711724 QUSER PJ 2 20 .0 0 0 .0 PSRW 1
QLZPSERV QUSER 711735 QUSER PJ 2 20 .0 0 0 .0 PSRW 1
QNMAPINGD QUSER 711721 QUSER PJ 2 25 .0 0 0 .0 PSRW 1
QNMAREXECD QUSER 711722 QUSER PJ 2 25 .0 0 0 .0 PSRW 1
QNPSERV QUSER 711732 QUSER PJ 2 20 .0 0 0 .0 PSRW 1
QPADEV0003 EDWARDK 744691 EDWARDK INT 3 20 .0 0 .0 0 .0 PGM-QP2TERM DEQW 1
QPADEV0003 EDWARDK 746311 EDWARDK BCI 3 20 .0 0 0 .0 PGM-sh TIMW 1
QSYSSCD QPGMR 711748 QPGMR BCH 3 20 .1 0 0 .0 PGM-QEZSCNEP EVTW 1

Completato
```

Integrazione: toolkit

```
14 print("<html> WRKSPLF listing for <b> $spooluser </b> ");
15 print("<title> spool list</title>");
16 print("<br> <hr><table border=1 cellpadding=5 cellspacing=5>");
17
18 $conn = i5_connect($i5_server_ip, $i5_uname, $i5_pass);
19 if ($conn === false) {
20     print("<br>FAIL : Failed to connect to server : $i5_ser
21     user name : $i5_uname and password : $i5_pass");
22     $errorTab = i5_error();
23     var_dump($errorTab);
24     die();
25 }
26
27 $desc = array(
28     "username" => $spooluser,
29     "outq" => "*ALL",
30     "userdata" => "*ALL"
31 );
32
33 $conn1 = i5_spool_list($desc, $conn);
34 if (!$conn1) die("<br>Command fail errno=".i5_errno()." msg=".i5_errormsg());
35 print '<tr>';
```

visualizza gli spool
in una pagina web

Integrazione: toolkit

File Modifica Visualizza Cronologia Segnalibri Strumenti Aiuto

http://10.11.1.1:89/Zend_Navigator_Demo/index.php?frame=spooled_

Zend Navigator
for system i

Active Jobs Spooled Files System Values User Profiles Database files

Work with Spooled Files [Refresh](#) [Logout](#)

Load User:

| File | User | Queue | User Data | Spool Number |
|----------|--------|--------|-----------|--------------|
| QPJOBLOG | DAVIDE | QPRINT | PHPJOB | 1 |
| QPJOBLOG | DAVIDE | QPRINT | PHPJOB | 1 |
| QPJOBLOG | DAVIDE | QPRINT | PHPJOB | 1 |
| QPJOBLOG | DAVIDE | QPRINT | PHPJOB | 1 |
| QPJOBLOG | DAVIDE | QPRINT | PHPJOB | 1 |
| QPJOBLOG | DAVIDE | QPRINT | PHPJOB | 1 |
| QPJOBLOG | DAVIDE | QPRINT | PHPJOB | 1 |
| QPJOBLOG | DAVIDE | QPRINT | PHPJOB | 1 |
| QPJOBLOG | DAVIDE | QPRINT | PHPJOB | 1 |
| QPJOBLOG | DAVIDE | QPRINT | PHPJOB | 1 |

Completato

File: QPJOBLOG(1) [Refresh](#)

[Cancel](#) [Delete](#) [Hold](#) [Release](#) [PDF](#)

Spooled File Details

| Job | Job Number | Date | Time | Status | Pages |
|--------|------------|----------|----------|--------|-------|
| PHPJOB | 567409 | 10/11/09 | 12:43:19 | RDY | 2 |

Spooled File Data

5722SS1 V5R4M0 060210 Job Log I5BUILD 11/10/09 12:43:19 Page 1

Job name PHPJOB User DAVIDE Number 567409
Job description EACJOBDB Library ZENDCORE

Integrazione: toolkit & framework

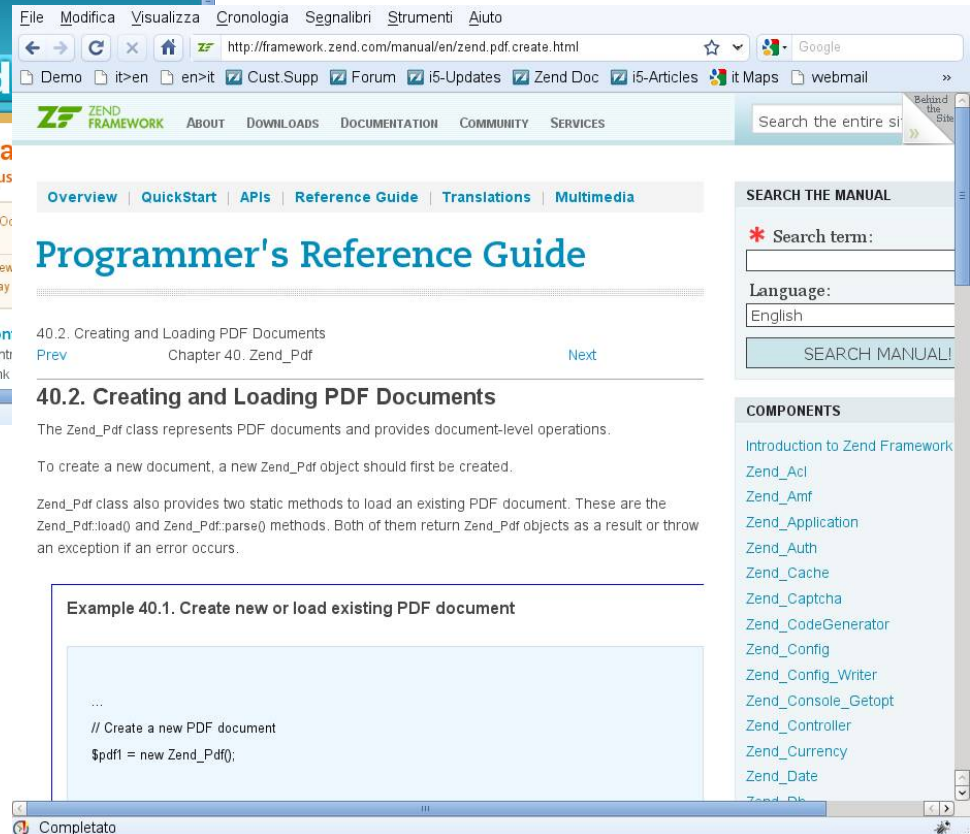

versione "community" delle libreria pdf

Integrazione: i5/OS e PASE

ZendCore for i5/OS “gira” nell'ambiente PASE

- i5/OS PASE is the AIX® runtime in i5/OS
- it is not an emulated environment

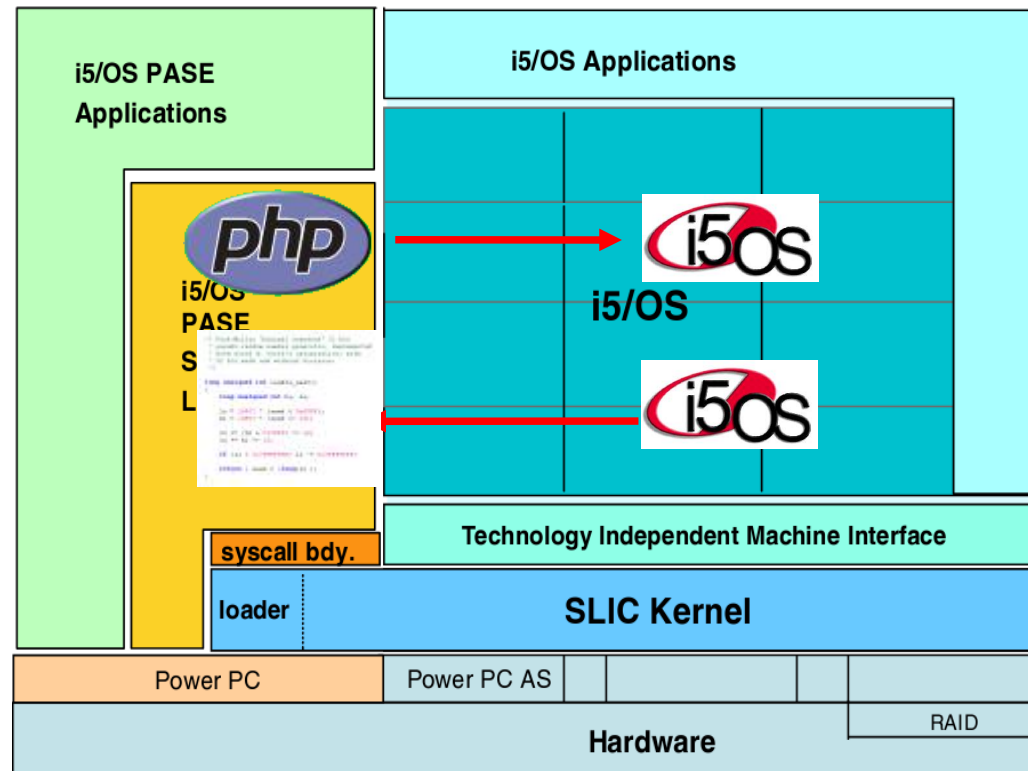

Integrazione: i5/OS and Pase

.....altro esempio: “stampa il report di listino con barcode in pdf”



FASCICOLO DI RICHIESTE DI RIFORNIMENTO IN VIGORE DAL

SETTORE: 10 MARKET

| DESCRIZIONE | U
M | -3 | | -2 | | -1 | | QUANTITA' | | ARTICOLO | Vend
PZ | MAX
SPED. | C. P. |
|------------------------|--------|-------------------|----------|-------------------|----------|-------------------|----------|-----------|---|----------|------------|--------------|-------|
| | | RICH.RIFOR | | RICH.RIFOR | | RICH.RIFOR | | 1 | 2 | | | | |
| | | | | | | | | | | | | | |
| GORGONZOLA ELITE AL K | P | 0,00
00/00/00 | 00/00/00 | 0,00
00/00/00 | 00/00/00 | 0,00
00/00/00 | 00/00/00 | | | 2240000 | | 51 | 3 |
| PRINGLES ORIGINAL | N | 0,00
00/00/00 | 00/00/00 | 0,00
00/00/00 | 00/00/00 | 0,00
00/00/00 | 00/00/00 | | | 3111960 | | 180 | 18 |
| PRINGLES PAPRIKA | N | 0,00
00/00/00 | 00/00/00 | 0,00
00/00/00 | 00/00/00 | 0,00
00/00/00 | 00/00/00 | | | 3111978 | | 180 | 18 |
| PRINGLES CRE&ONION | N | 0,00
00/00/00 | 00/00/00 | 0,00
00/00/00 | 00/00/00 | 0,00
00/00/00 | 00/00/00 | | | 3111986 | | 180 | 18 |
| PRINGLES DLHT AROMAS | N | 0,00
00/00/00 | 00/00/00 | 0,00
00/00/00 | 00/00/00 | 0,00
00/00/00 | 00/00/00 | | | 3111994 | | 180 | 18 |
| PRINGLES LIGHT | N | 0,00
00/00/00 | 00/00/00 | 0,00
00/00/00 | 00/00/00 | 0,00
00/00/00 | 00/00/00 | | | 3112000 | | 180 | 18 |
| DIETORELLE FRUTTI ASSO | N | 0,00
00/00/00 | 00/00/00 | 0,00
00/00/00 | 00/00/00 | 0,00
00/00/00 | 00/00/00 | | | 3206455 | | 120 | 12 |
| DAYGUM PROTEX S/Z | N | 20,00
10/09/07 | 00/00/00 | 20,00
17/09/07 | 00/00/00 | 20,00
24/09/07 | 00/00/00 | | | 3502168 | | 800 | 20 |
| DAYGUM MICROTECH | N | 20,00
27/08/07 | 00/00/00 | 20,00
10/09/07 | 00/00/00 | 20,00
24/09/07 | 00/00/00 | | | 3502853 | | 2000 | 20 |
| AQUAF MENTA FORTE GOMM | N | 20,00
13/09/04 | 00/00/00 | 20,00
20/09/04 | 00/00/00 | 20,00
11/10/04 | 00/00/00 | | | 3503299 | | 120 | 20 |
| AQUAF WHITENING GOMME | N | 20,00
13/09/04 | 00/00/00 | 20,00
20/09/04 | 00/00/00 | 20,00
11/10/04 | 00/00/00 | | | 3503315 | | 120 | 20 |
| HAPPYDENT DEFENSIVE | N | 20,00
19/12/05 | 00/00/00 | 20,00
02/01/06 | 00/00/00 | 20,00
20/02/06 | 00/00/00 | | | 3503398 | | 300 | 20 |
| RESET VIGORSOL BOX | N | 40,00
14/03/05 | 00/00/00 | 20,00
02/03/05 | 00/00/00 | 20,00
13/08/05 | 00/00/00 | | | 3503893 | | 800 | 20 |

Integrazione: i5/OS e Pase

la richiesta del cliente:

“print my invoices to pdf format in i5”

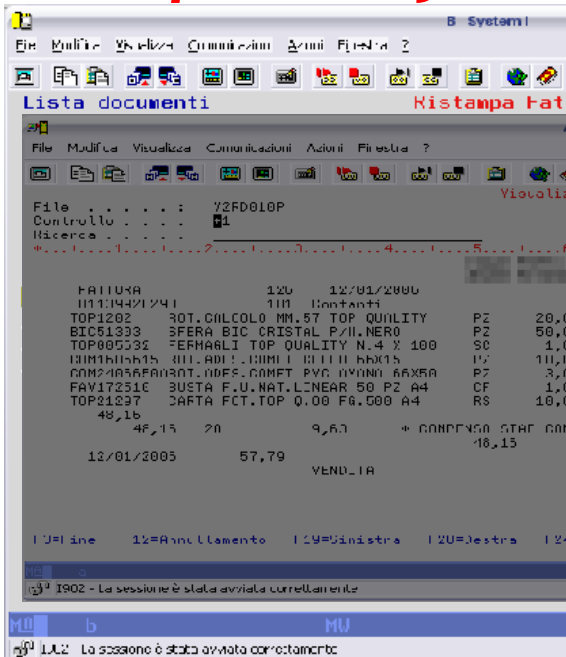

```

31 //ciclo tutti record
32 while ($row=db2_fetch_assoc($result)) {
33
34     $data=$row['data'];// record da db
35     $skip=substr($data,0,3);
36     $space=substr($data,3,1);
37     // salto n° righe
38     if(strlen(trim($skip))>0) {
39         for($count;$count<$skip;$count++) {
40             $line+=$hline;

```

1) Hold spool

GRANDI MOLINI ITALIANI

SEDE LEGALE E AMMINISTRATIVA
Via S. Maria Maddalena 10 - 31044 Portofino (PD)

ROVIGO - V.LE PORTA ADIGE

LUOGO DI ORIGINE

The final result

| | | | | | | | | | |
|-------------------------------|---------------------------|---|--------------|-------------------|---|-----------------|--------|----------|---------------|
| JOB: DESTINAZIONE DEI DIVERSI | | TIPO DOCUMENTO
RAPPURA | | | | | | | |
| N. 402804 | | PSE 1 | | | | | | | |
| DATA 31/07/2007 | | Tel. 0532/412646 | | | | | | | |
| COD. CLIENTE
0020 | PREFERENZ.
00959430387 | PL. ORD. DE | DOC. ORD. DE | COD. GESTE
A04 | AGENTE | | | | |
| TRASPONDA CIBACF | PERIO | DATA | QUANTITA' | DESCRIZIONE | MARKA D'APPARTENENZA | | | | |
| MITTENTE | ARRIVO | 782 | Rim.dinetta | 60 gg d.f. | BANCA NAZIONALE DEL LAVORO S.P.
ABICAB 01005-01004 | | | | |
| DOC. ABIL. | ES. A SPA | DESCRIZIONE | IMBALLI | UNA | QUANTITA' | PREZZO UNITARIO | SCONTI | COD. IVA | IMPORTO NETTO |
| DOSOFF | 1 | GRANDI MOLINI - NUOVA GAMMA
FARINA 0 SOFFIATE -SC 25 | 20 | KG | 500,00 | 0,53 | | 04 | 265,00 |

Integrazione: i5/OS e Pase

-una settimana
“send my invoices”

```
15 // parametri
16 $to=trim($argv[1]);
17 $cli_doc = trim(substr($argv[2],0,6));
18 $num_doc = trim(substr($argv[3],0,6));
19 $dat_doc = trim(substr($argv[4],0,8));
20
21 // nome del doc
22 $nome_doc=$cli_doc."_".$dat_doc."_".$num_doc'.pdf';
```

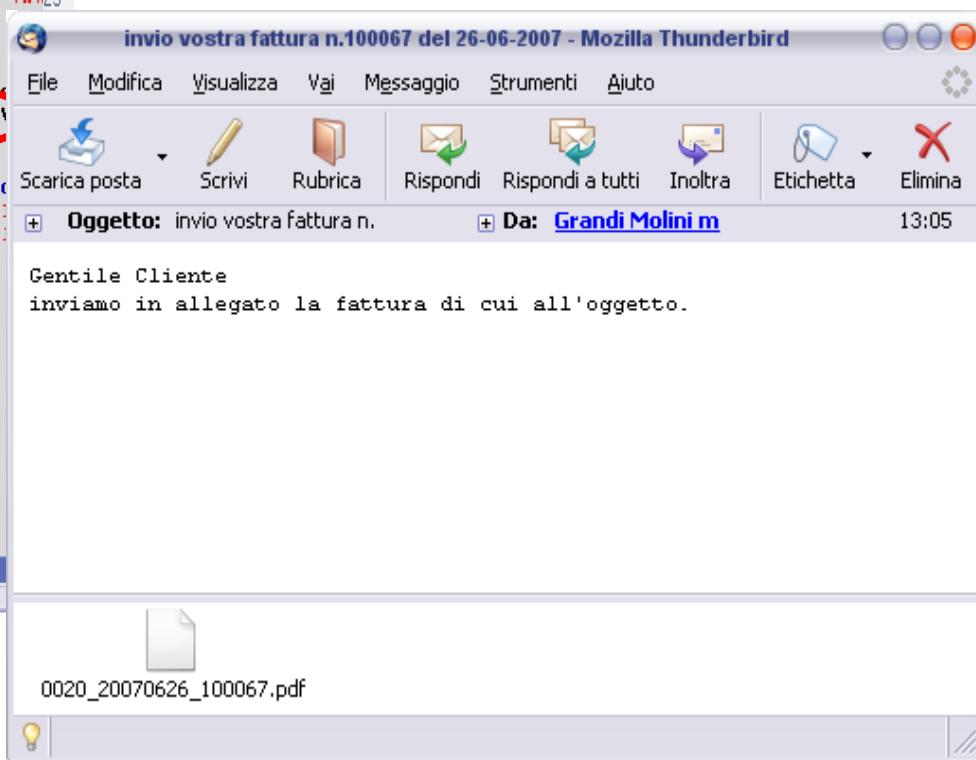
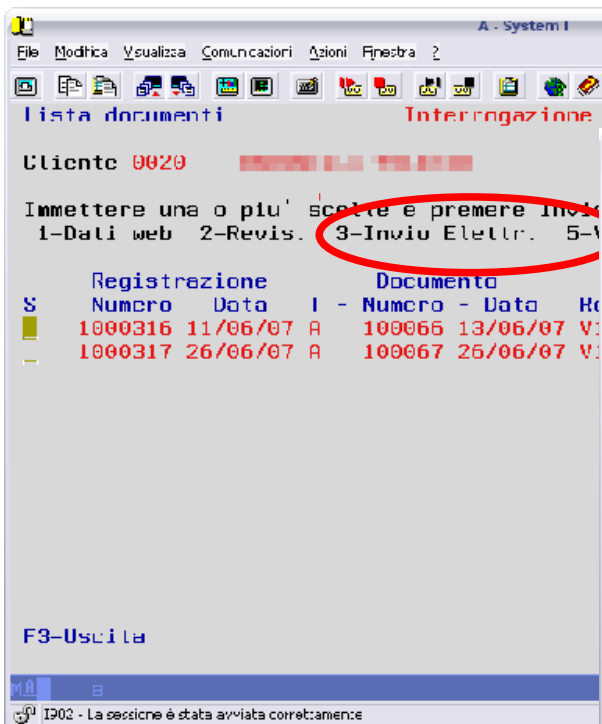

Integrazione: MySQL & DB2

- MySQL database supported on IBM i Integrated File System
 - enables customers to deploy PHP MySQL-based applications on IBM i
- DB2 Storage Engine now available with MySQL
 - enables MySQL-based applications to store data in DB2 for IBM i
 - available with MySQL Community Edition 5.1.33
- New IBM Redbook
 - “Using IBM DB2 for i as a Storage Engine of MySQL” **SG24-7705**

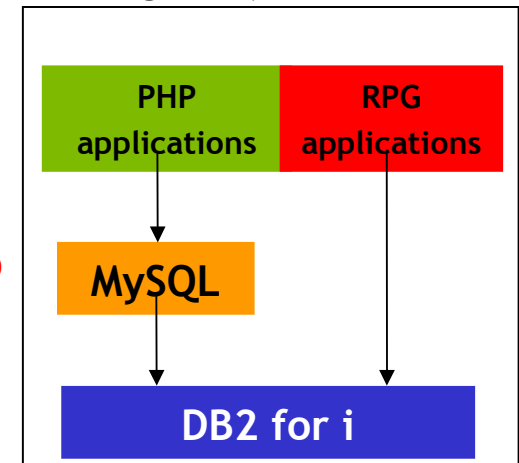

<http://dev.mysql.com/downloads/mysql/5.1.html#i5os-savf>

System i customers get the benefit of being able to use thousands of new open source applications while continuing to have one easy to use data store with DB2.

Integrazione: mySQL & DB2

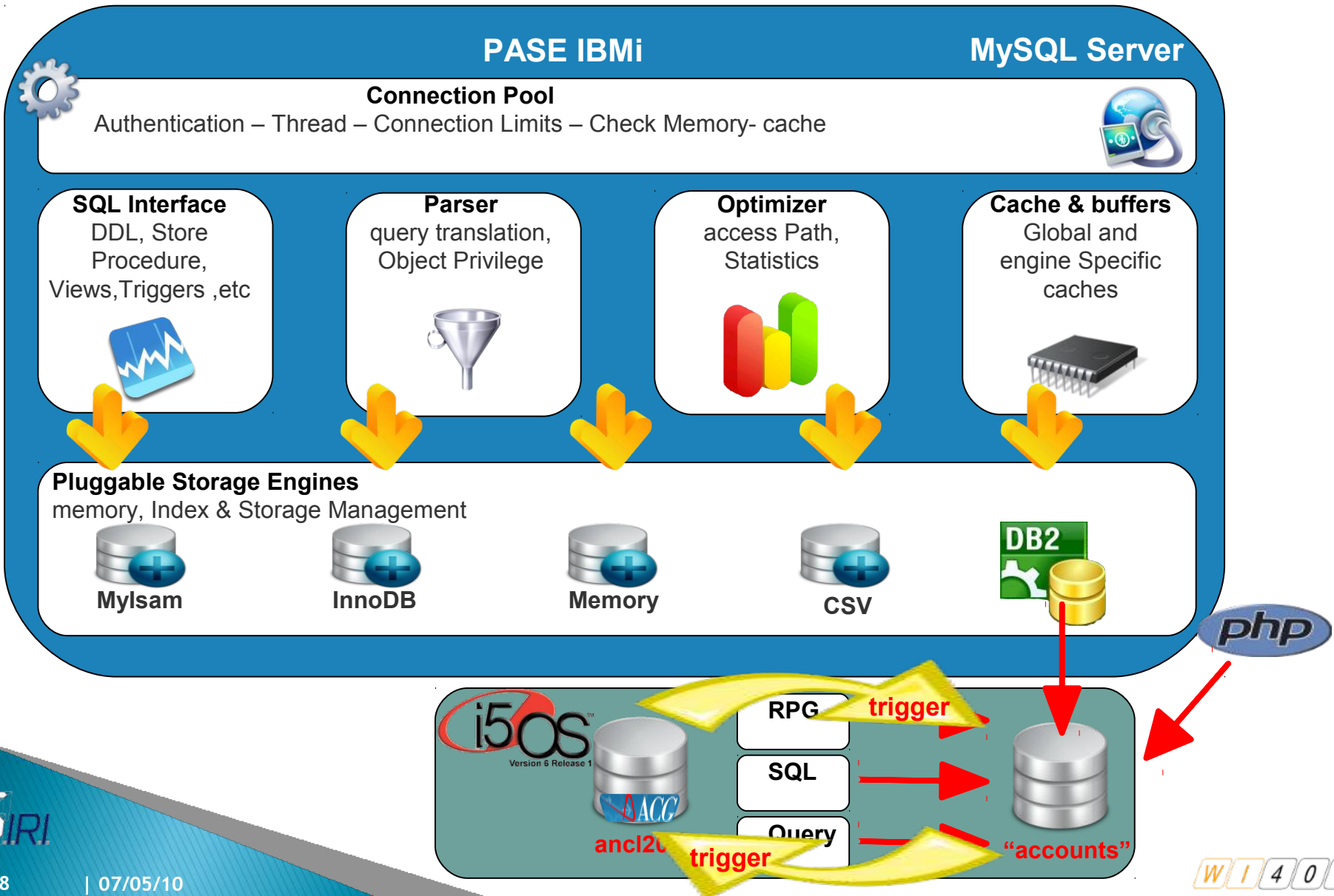

Integrazione: mySQL & DB2 - sugarCRM



Benvenuto, **davide** [Esci] | [Il mio profilo](#) | [Dipendenti](#) | [Admin](#) | [Training](#) | [About](#) | [Site Pagina](#)

Sitemap CERCA

Home Vendite Marketing Supporti Attività Collaborazione Report

Home Grafici

Ultima vista: I PROFUMI PREZI ABC FUEL CO 297 SIRI-INFORMATICA davide

Scorciatoie

- Nuovo Contatto
- Nuova Azienda
- Nuovo Lead
- Nuova Opportunità
- Nuovo Reclamo
- Segnala Bug

AGGIUNGI DASHLET DI SUGAR ? Help

All Opportunities By Lead Source By Outcome

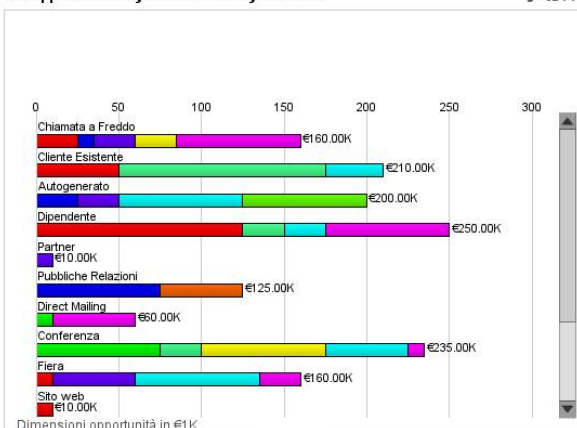

Dimensioni opportunità in €1K

- | | | | |
|-----------------|--------------------|---------------------|--------------|
| Prospecting | Propos. Valore | Proposta Economica | Chiuso Perso |
| Qualificazione | Id. Decision Maker | Negoziazione/Review | |
| Analisi Bisogni | Analisi Percezione | Chiuso Vinto | |

All Opportunities by Lead Source

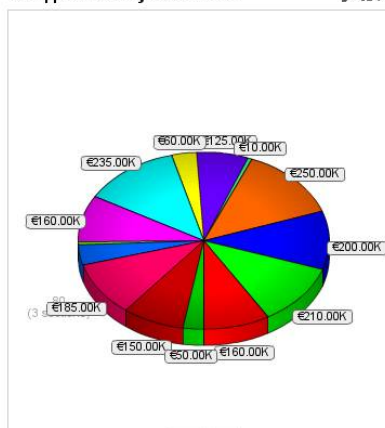

- | | | |
|-------------------|---------------------|----------------|
| Chiamata a Freddo | Dipendente | Direct Mailing |
| Cliente Esistente | Partner | Conferenza |
| Autogenerato | Pubbliche Relazioni | Fiera |



Benvenuto in
SUGARCOMMUNITY EDITION™
SIRI FOR IBMi

INSERIRE I DATI PER L'IDENTIFICAZIONE, GRAZIE

NOME UTENTE:

PASSWORD:



OPZIONI

LOGIN

Integrazione: mySQL & DB2 - sugarCRM

Modifica **Gestione Clienti**

| | |
|-------------------------|---|
| Codice | M117 |
| Ragione sociale . . . | <u>SIRI-INFORMATICA</u> |
| Codice di ricerca . . . | <u>SIRI-INFORMATIC</u> |
| Indirizzo | <u>VIA C.COLOMBO 4</u> |
| Localita' | _____ |
| Provincia | _____ |
| CAP | _____ |
| Partita IVA | _____ |
| Persona | <u>G</u> Cd fiscale/P.IVA |
| Numero telefono . . . | _____ |
| Fax | _____ |
| Nota | <u>modificato da acg il 22/03/10</u> |

F=Fisica G=Giuri

Aziende: SIRI-INFORMATICA

INFORMAZIONI AZIENDA

| | |
|----------------|--|
| NOME: * | <input type="text" value="SIRI-INFORMATICA"/> |
| SITO WEB: | <input type="text" value="HTTP://"/> |
| TICKER: | <input type="text"/> |
| AZIENDA PADRE: | <input type="text"/> <input type="button" value="SELEZIONA"/> <input type="button" value="AZZERA"/> |
| PROPRIETARIO: | <input type="text"/> |
| SETTORE: | <input type="text" value="INFORMATICA - ELETTRONICA"/> ▼ |
| TIPO: | <input type="text" value="ALTRO"/> ▼ |
| CAMPAGNA: | <input type="text"/> <input type="button" value="SELEZIONA"/> <input type="button" value="AZZERA"/> |
| ASSEGNATO A: | <input type="text" value="DAVIDE"/> <input type="button" value="SELEZIONA"/> <input type="button" value="AZZERA"/> |

INDIRIZZO

| | |
|----------------------------|--|
| INDIRIZZO DI FATTURAZIONE: | <input type="text" value="VIA C.COLOMBO 4"/> |
| COMUNE : | <input type="text" value="SCORZE'"/> |
| PROVINCIA: | <input type="text" value="VE"/> |
| C.A.P.: | <input type="text" value="30030"/> |



Cosa posso fare con PHP

- # - quali tematiche affrontare
- l'open-source

IBMi e l'open-source

- attraverso l'engine db2 access via “mysql”, sono “a portata di mano” per effettuare il “porting” di tipiche applicazioni opensource

- **SUGARCRM for i5** - CRM



<http://www.sugarcrm.com>

- **MANTIS400** - HELP DESK



<http://www.mantisbt.org>

IBMi e l'open-source



[FREE TRIAL](#)

[BUY NOW](#)

1.877.842.7276 | [Web](#)

[Products](#) | [Services](#) | [Open Source](#) | [Customers](#) | [Partners](#) | [Company](#) | [Store](#)

I want to...

[organize & share customer information](#)

[measure & report across my company](#)

[analyze & collaborate with customers & employees](#)

[develop applications & collaborate with community](#)

Customer Support

Case: System is too slow

Number: 994220
Created By: Jason
Modified By: jrdal
Priority: Medium
Subject: System is too slow
Resolution: Manager complaining about slow
Resolution: Apple new system settings

Name: SugarCRM
Website: www.sugarcrm.com
Email: sales@sugarcrm.com (Primary)

Google Maps: 10050 North Wolfe Road

Accounts: Cortini Shipping

9 connections work at Cortini Shipping

- Cary Sanderson
- Ty Pizzi

- ✓ I want to share key information with customers and partners
- ✓ I need deep reporting capabilities
- ✓ I want control of my data

[LEARN MORE](#) [DEMO](#)

[SugarCRM](#) | [Sugar Open Source](#) | [SugarExchange](#) | [SugarForge](#) | [Developers](#) | [Forums](#) | [Blog](#) | [Wiki](#) | [Downloads](#) | [De](#)

SUGAR COMMUNITY EDITION.

[Open Source CRM](#) | [Community](#) | [Downloads](#) | [Installation](#) | [Documentation](#) | [Help](#) | [De](#)

Hot off the press: Sugar 5.5 Community Edition released



Demo

Ready for a test drive? Take Sugar Open Source out for a spin.



Download

Take control, download Sugar Open Source.



Installation

Get help installing Sugar Open Source.



Community

Check out all the resources our vibrant community offers.

Open Source CRM

IBMi e l'open-source

Mantis/400 Free Native HelpDesk for i5/OS, DB2/400 and PHP

[SUPPORT](#) [about us](#) [contacts](#)

FREE [Help Desk Software](#) runs on the AS/400, FREE Installation Support...

[MANTIS/400](#), is an AS/400-specific adaptation of the popular "Bug Tracker" [MANTIS Help Desk](#). Now, Mantis runs NATIVE on the AS/400, using PHP.

- Create/manage Internal/External **Support Issues**
- **Any web browser**, any client operating system
- **E-mail notification** as Issues are managed
- Customizable Issue workflow
- Data usable from **RPG, Query, COBOL, SQL...**
- Did we mention [FREE software and support?](#)
- and lots more...

Ira Chandler

➔ **Request FREE CD**
Easy install - Mantis, PHP, MySQL, other PHP apps, and more!

➔ **FREE Support**
FREE install support using [Mantis!](#) Direct Questions/Answers...

➔ **LIVE DEMO on System**
On a Model 520 - Create a Login then check your e-mail!

➔ **Learn more about Mantis...**
Who is behind it, how you can support them...

➔ **LINKS to PHP Support Resources**
ALL known resources for PHP on the System i...

RPG to Web with php
wiki
shop
forums
help desk
collaborate
site content mgmt

Ask Quick Question

SIRI e il PHP

Inizio approccio php nel 2003

- ▶ Realizza il primo applicativo per gestire commesse e costi

PHP e IBMi

- ▶ Nel 2006 SIRI inizia la sua “avventura” con il PHP in ambito AS400
- ▶ Nel 2007 inizia una consistente fase di “investimento” nella tecnologia php, ponendo le basi per la sua “architettura **WI400**”
- ▶ Nel 2008 SIRI diventa partner ufficiale ZEND con il programma “Powered by Zend”



Oggi

- ▶ Sta continuamente potenziando il “laboratorio” PHP con nuove risorse da un lato, e formando l'attuale RPG in PHP
- ▶ Iniziato il programma di partnership per la distribuzione di WI400

Certified Support

- ▶ nell'ambito IBMi, vanta oltre 20 anni di esperienza
- ▶ personale tecnico Zend Certified Engineer
- ▶ ha acquisito le migliori competenze e “best-practice” in PHP adattandole all'i5OS





Sviluppare codice con PHP

- # - come si sviluppa con PHP
- strumenti rapidi di sviluppo

Lo sviluppo del codice

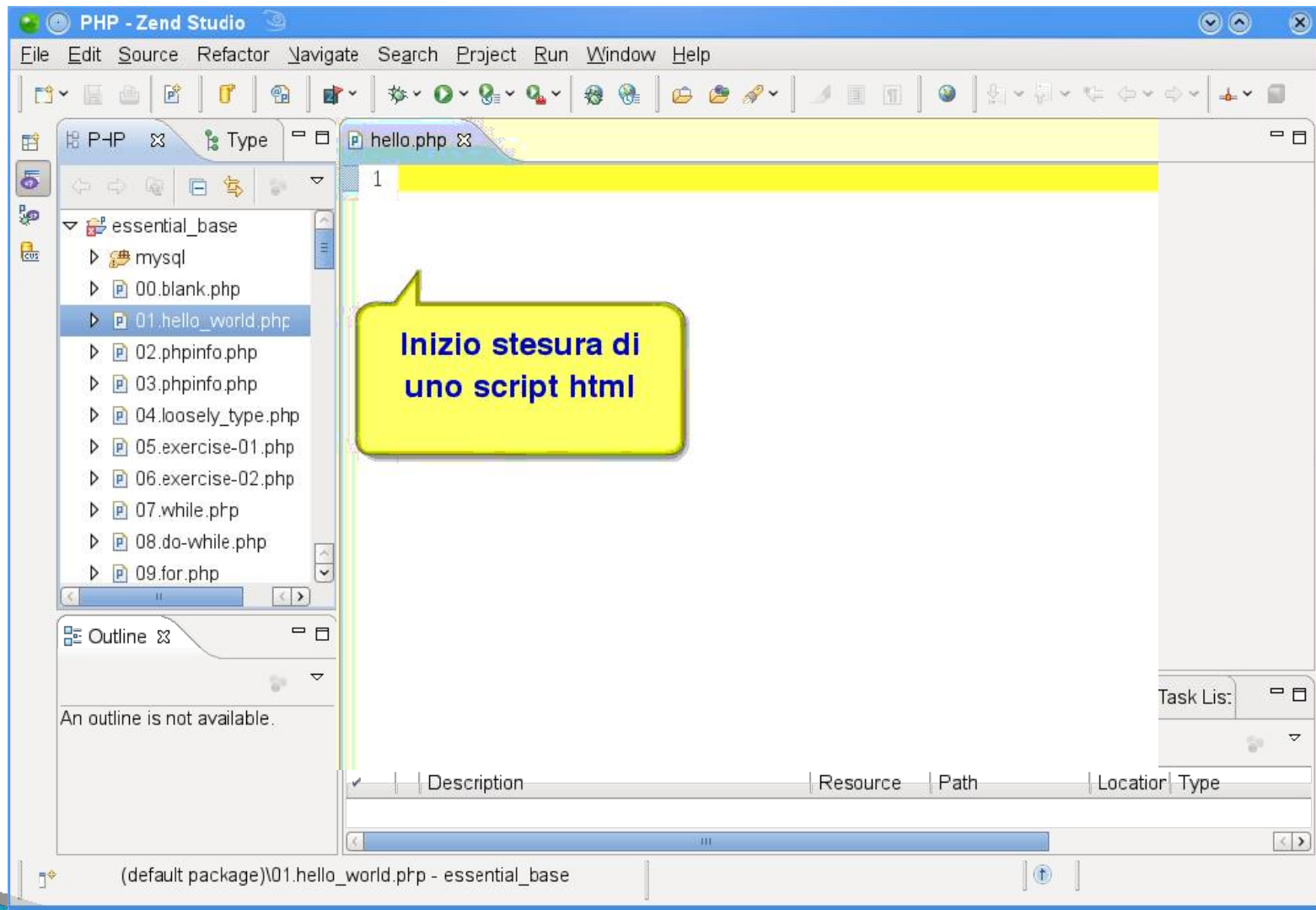

Lo sviluppo del codice con MVC



The screenshot shows the Wikipedia page for 'Model-View-Controller'. At the top left is the Wikipedia logo and a search bar. The page title is 'Model-View-Controller' with navigation tabs for 'voce', 'discussione', 'modifica', and 'cronologia'. Below the title is a notice: 'Wikimedia Italia ha realizzato una video guida per imparare ad utilizzare e a modificare le pagine di Model-View-Controller'. A red banner states: 'Questa voce sull'argomento informatica è solo un abbozzo. Contribuisci a migliorarla secondo le convenzioni di Wikipedia e i suggerimenti del p...'. The main text begins: 'Model-View-Controller (MVC, talvolta tradotto in italiano **Modello-Vista-Controllore**) è un pattern architeturale molto diffuso nello sviluppo di interfacce grafiche di sistemi software object-oriented.'

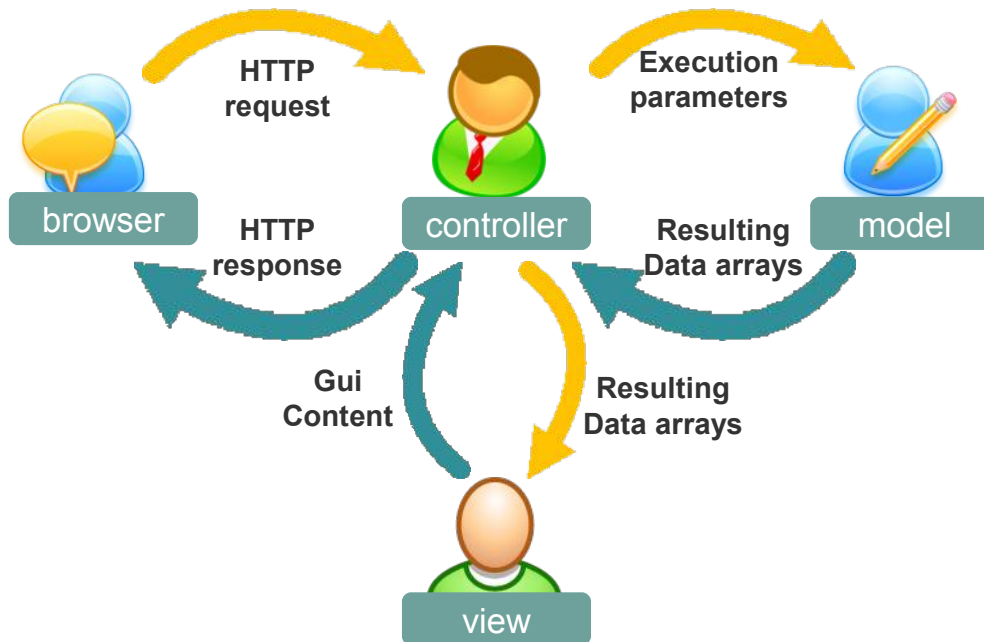

Lo sviluppo del codice con WI400

WI400 Action Architecture

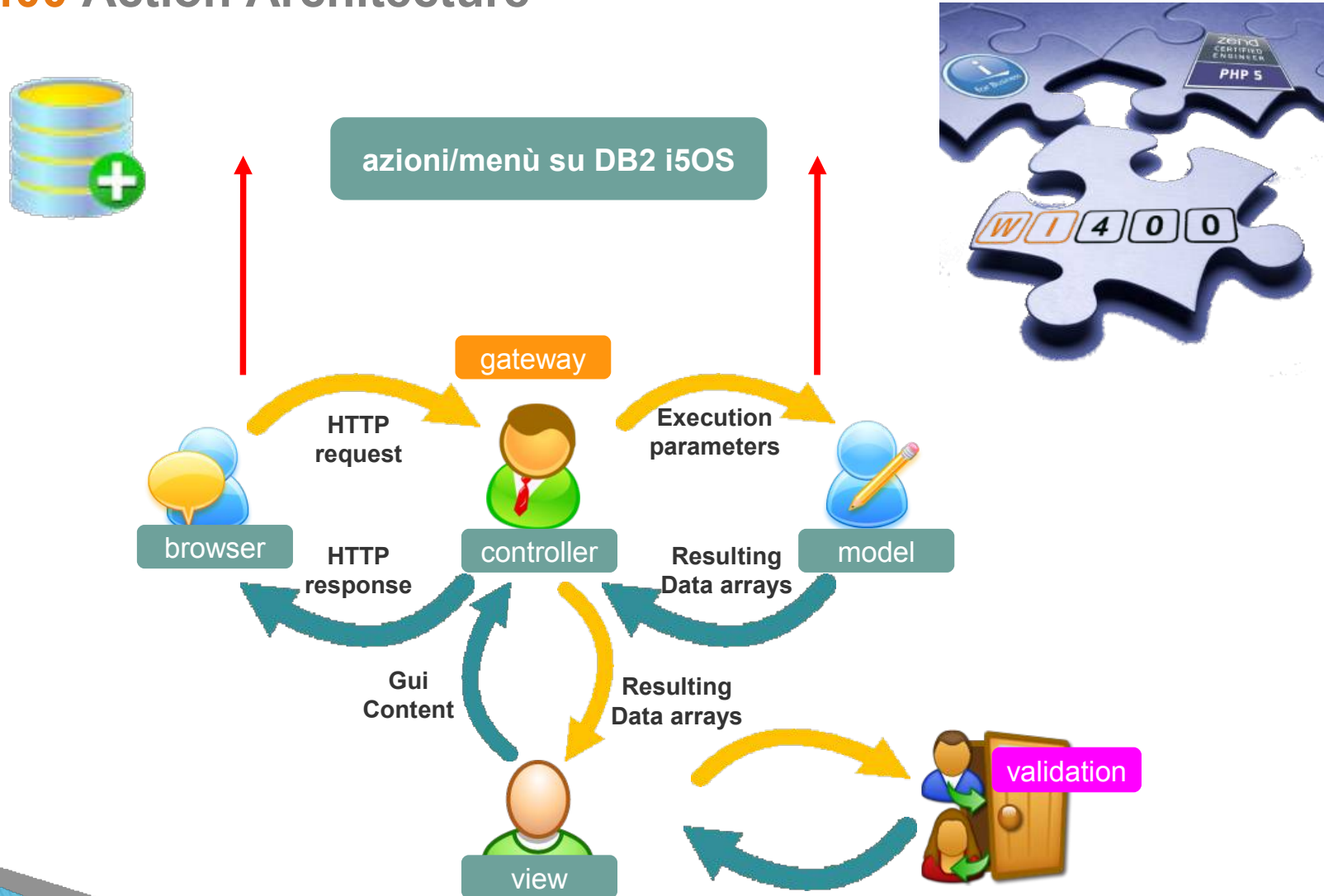

Lo sviluppo del codice con WI400

WI400 Action Architecture

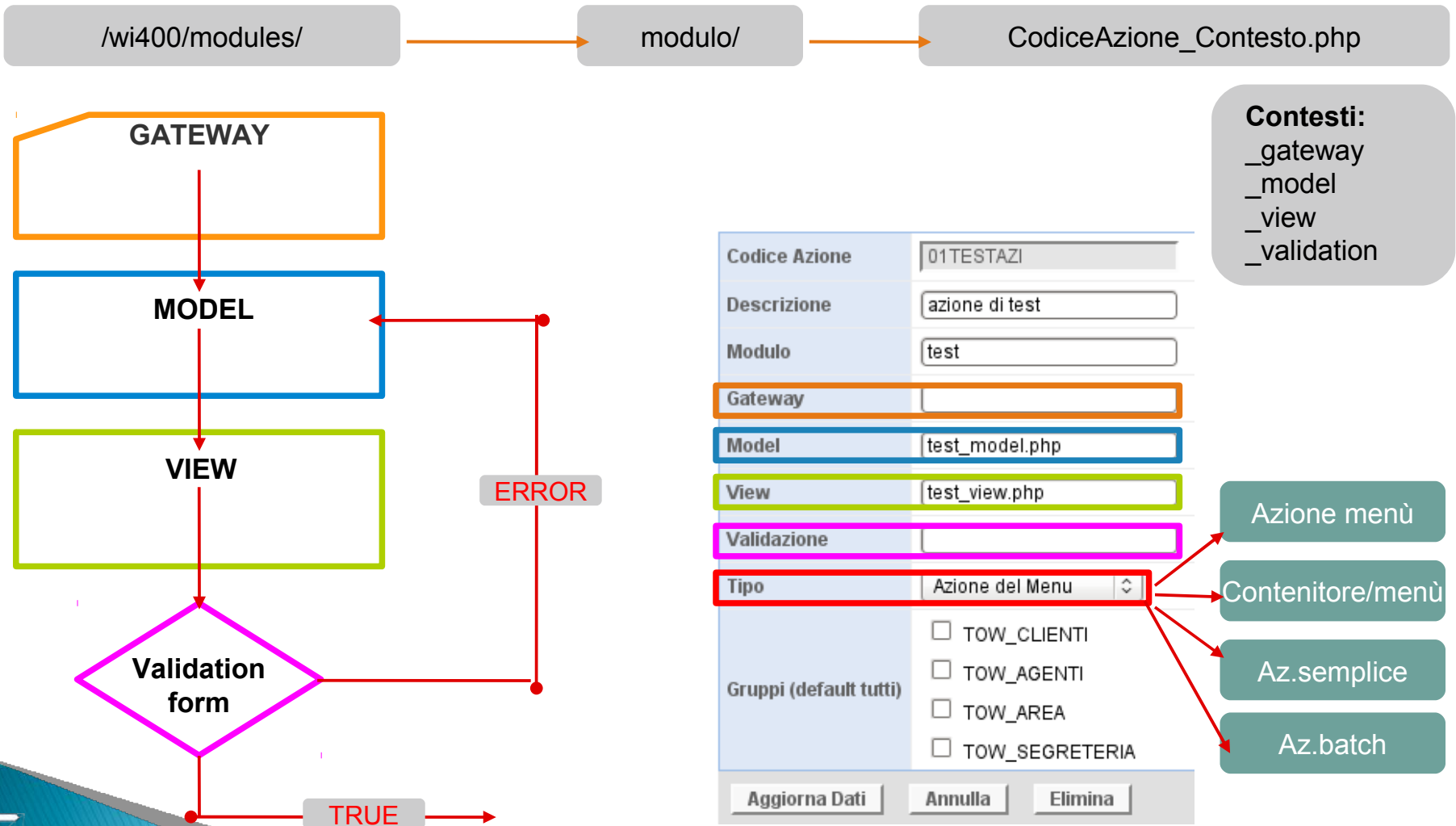

Lo sviluppo del codice con WI400

[http:// www.wi400.com](http://www.wi400.com)

The image displays a screenshot of the WI400 web application interface. On the left, there is a navigation menu with sections like 'Selezioni', 'Menu funzionalità', 'Gestione e-mail', 'menù di test', 'Menu WI400', and 'Utente'. The main content area shows a search form for 'Ragione Sociale' with a dropdown set to 'contiene' and the text 'ROSSI'. Below the form is a table of search results:

| Codice di ricerca cliente | Indirizzo cliente | Località cliente | Provincia cliente |
|---------------------------|---------------------|------------------|-------------------|
| ***COLAGROSSI E | VIA NETTUNENSE, 200 | PAVONA | RM |
| ***COLAGROSSI E | VIA NETTUNENSE, 200 | PAVONA | RM |
| ***COLAGROSSI F | VIA NETTUNENSE, 202 | PAVONA | RM |

Overlaid on the bottom right is a screenshot of a code editor (Zend Studio) showing PHP code for a search function. The code is circled in red and consists of the following lines:

```
20 <?
21 // Solo Lista
22 $miaLista = new wi400List("TABELLA_ACG", true);
23 $sql = "A.CDCLI=G.CDCLI";
24 $miaLista->setFrom("DAT_DEMO/ANCL200F AS A, DAT_DEMO/GCLP200F AS G");
25 $miaLista->setWhere($sql);
26 $miaLista->setOrder("RASCL");
27 $cols = getColumnListFromTable("ANCL200F", "DAT_DEMO");
28 $miaLista->setCols($cols);
29
30 $miaLista->dispose();
31
32
33
```

A yellow starburst graphic on the left contains the text: **Less than 10 lines of code**



Lo sviluppo del codice con WI400

[http:// www.wi400.com](http://www.wi400.com)



WI400
Web Interface AS400

Company WI400 News Supporto Contatti

abbiamo creato...
...la nuova veste dell'AS400!

Download now

<http://www.linkedin.com/groups?gid=2896949>

info@wi400.com

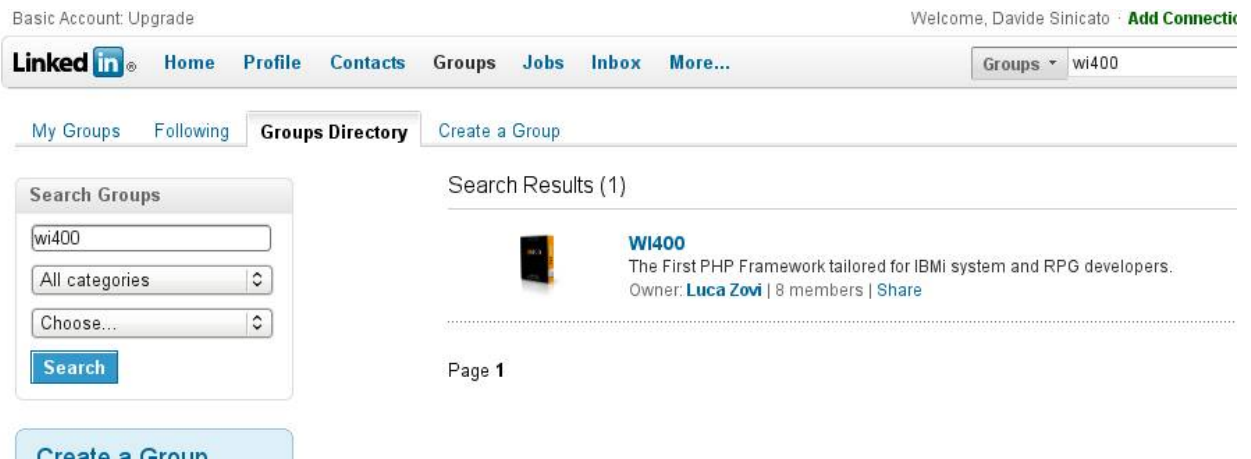

Basic Account: Upgrade

Welcome, Davide Sinicato · Add Connecti

LinkedIn Home Profile Contacts Groups Jobs Inbox More...

Groups wi400

My Groups Following Groups Directory Create a Group

Search Groups

wi400

All categories

Choose...

Search

Search Results (1)

WI400
The First PHP Framework tailored for IBMi system and RPG developers.
Owner: **Luca Zovi** | 8 members | Share

Page 1

Create a Group





| - Question Time ?

